

# SK6612M

## 355/360/365W

### 72 CELLS

### MONO 5BB

### High Efficiency Module



#### PRODUCT FEATURES



##### High Efficiency

Output efficiency up to 18.8%  
0~3% positive power tolerance  
5-busbar has better collected current capability



##### Excellent Low-Irradiance

Well generation capacity and temperature stability especially in faint lighting conditions



##### Anti-PID Design

Products satisfy IEC62804 tests by anti-PID cell and module technology



##### Harsh Environment Adaptability

Salt mist resistance  
Ammonia resistance  
Dust and sand resistance



##### Robust Mechanical Durability

Strong mechanical durability of 5400Pa snow load, 2400Pa wind load



#### COMPANY PROFILE

Akcome Optronics is a leading manufacturer and service provider of professional photovoltaic cells and modules that can be widely utilized in residence, commerce and ground photovoltaic plant. Founded in 2010, and became wholly-owned subsidiary of Jiangsu Akcome Science & Technology Co., Ltd. (002610).

Akcome Optronics provides PV products with exceptional power output and reliability by integrating rigorous design, advanced production technology and fully automatic production equipment. Strict quality control and test standards confirm its pursuit of zero-defect output.

#### LINEAR PERFORMANCE WARRANTY



Product warranty on materials and workmanship



Linear power output warranty

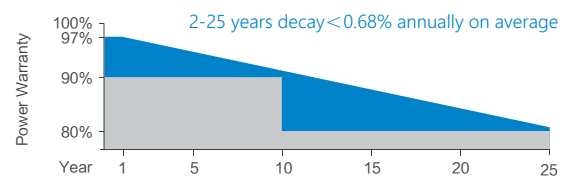

#### CERTIFICATES

**IEC 61215 / IEC 61730**

**ISO 9001: 2015**

Quality Management System

**ISO 14001: 2015**

Environmental Management System

**OHSAS 18001: 2016**

Occupational Health & Safety Management System

\*Certification requirements vary in different markets, please consult with Akcome Optronics sales team for appropriate certification.



# SK6612M<sub>355/360/365W</sub>

## ELECTRICAL PARAMETERS @ STC

Max. Power Output Pmax (W)	355	360	365
Power Tolerance	0~+3%	0~+3%	0~+3%
Max. Power Voltage Vmp (V)	38.5	38.5	38.6
Max. Power Current Imp (A)	9.22	9.35	9.46
Open Circuit Voltage Voc (V)	47.3	47.8	48.0
Short Circuit Current Isc (A)	9.73	9.83	9.92
Module Efficiency (%)	18.3	18.5	18.8

\*STC (Standard Test Condition): Irradiance 1000W/m<sup>2</sup>, Cell Temperature 25°C, Air Mass 1.5

## ELECTRICAL PARAMETERS @ NOCT

Max. Power Output Pmax (W)	262.4	266.4	270.6
Max. Power Voltage Vmp (V)	35.69	35.95	36.13
Max. Power Current Imp (A)	7.35	7.41	7.49
Open Circuit Voltage Voc (V)	43.77	44.24	44.43
Short Circuit Current Isc (A)	7.86	7.94	8.02

\*NOCT(Nominal Operating Cell Temperature): Irradiance 800W/m<sup>2</sup>, Ambient Temperature 20°C, Wind Speed 1m/s

## TEMPERATURE COEFFICIENTS

Temperature Coefficients of Pmp	-0.39%/°C
Temperature Coefficients of Voc	-0.30%/°C
Temperature Coefficients of Isc	+0.050%/°C

## MECHANICAL PARAMETERS

Cell Type	Mono 156.75×156.75mm
Number of Cells	72pcs(6x12)
Dimensions ( L*W*H )	1957x992x40mm
Weight	22.5kg
Frame	Anodised Aluminum
Junction Box	IP67, 3 bypass diodes
Cable, Length	4.0mm <sup>2</sup> , 900mm

## OPERATING CONDITION

Maximum System Voltage(V)	1000(DC)
Operating Temperature(°C)	-40~+85
Max. Wind Load / Snow Load(pa)	2400/5400
Max. Over Current(A)	15
Application Class	Class A
Fire Rating	Class C
NOCT(°C)	45±2

## PACKAGE INFORMATION

Truck 9.6m / 13m / 17.5m	459/ 612 / 1257pcs
Container 20'GP / 40'GP / 40'HQ	240 /528/ 572pcs
Quantity / Pallet	24pcs

## ASSEMBLY DRAWING (Unit:mm)

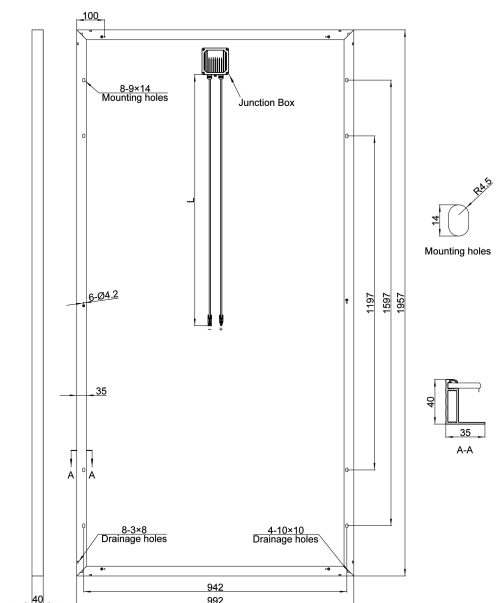

## I-V CURVES / SK6612M-365

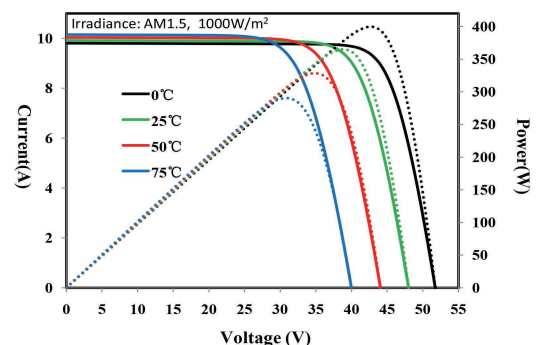
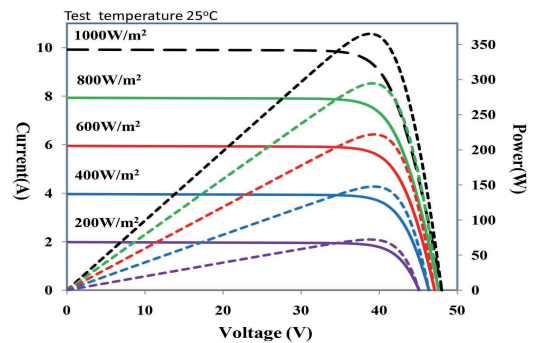

AKCOME OPTRONICS SCIENCE & TECHNOLOGY CO.,LTD.

Add: No. 110 Jintang Road, Zhangjiagang economic and Technological Development Area, Jiangsu P.R. China

Tel: 400-101-7000

Email: modulesales@akcome.com

[www.akoptronics.com](http://www.akoptronics.com)

